

GENERAL NOTES

1. ALL AXLES AND SHAFTS ARE CHROME PLATED.
2. ALL ROLLERS AND PIVOT POINTS ARE EQUIPPED WITH TEFLON SELF-LUBRICATING BEARINGS.
3. ADVANCE LIFTS, INC. TO SUPPLY 5 GALLONS OF A MULTI VISCOSITY ISO-46 GROUP II BASE OIL & (1) 20' OF .5" EXTRA HEAVY DOUBLE WIRE BRAID HOSE (SAE 100R2) FOR THE POWER UNIT TO THE EQUIPMENT CONNECTION WITH .5" JIC FEMALE SWIVEL FITTINGS ON THE ENDS.
4. REINFORCE CONCRETE TO SUIT LOCAL SOIL CONDITIONS PLUS YOUR DESIRED SAFETY FACTORS.
5. OVERALL POWER UNIT SIZE: 26" WIDE X 12" LONG X 15" HIGH (INCLUDING MOTOR, AND BRACKETS FOR FLOOR MOUNTING).
6. CONCRETE WORK, REINFORCING, BUILDING MODIFICATIONS, PIPING, ELECTRICAL WIRING, EMBEDDED ITEMS, INSTALLATION, ETC. (BY OTHERS)
7. ADVANCE LIFTS, INC. TO SUPPLY:
 - (1) 20' LG. PUSHBUTTON COILCORD.
 - 20' OF .25" I.D. HYDRAULIC HOSE WITH .25" FEMALE JIC SWIVEL FITTINGS ON THE ENDS FOR THE VENT LINE CONNECTION FROM THE BASEFRAME TO THE POWER UNIT.
 - INSTALLATION PACKAGE AS OUTLINED IN GENERAL NOTE #3.
8. FINISH: BLUE PAINT
9. PIT DIMENSION TOLERANCES ARE PLUS .25", MINUS 0" (+ .25", - 0").
10. TYPICAL ELECTRICAL DIAGRAM FOR THIS UNIT: E22-001
TYPICAL HYDRAULIC DIAGRAM FOR THIS UNIT: H13-160

SPECIFICATONS

CAPACITY: 6,000 LBS MAX. LIFING CAPACITY
3,500 LBS MAX. AXLE CAPACITY
3,250 LBS MAX. AXLE CAPACITY

PLATFORM: 72" WIDE X 120" LONG SAFETY TREAD DECK
REMOVABLE STEEL GUARDRAILS
12" LONG X 72" WIDE HINGED STEEL BRIDGE
BRIDGE LIFTING AND SAFETY CHAINS
BEVEL TOE GUARDS
BLACK AND YELLOW SAFETY STRIPING

SPEED: 10 FPM

TRAVEL: 58" (FROM AN 8" LOWERED HEIGHT)

LOWERED HEIGHT: 8"

POWER UNIT: 5 HP MOTOR 230V 60Hz 3 PH

CONTROL: UP-DOWN WEATHER-PROOF PUSHBUTTON
STATION, PENDANT TYPE NEMA 1, 3, 3R, 4, 4X.

IN NEMA 12 ENCLOSURE: MAGNETIC STARTER,W/ OVERLOAD
230V TO 24 V CONTROL TRANSFORMER

APPROXIMATE SHIPPING WEIGHT: 2,860 LBS

ALL DIMENSIONS ARE IN INCHES UNLESS OTHERWISE NOTED.

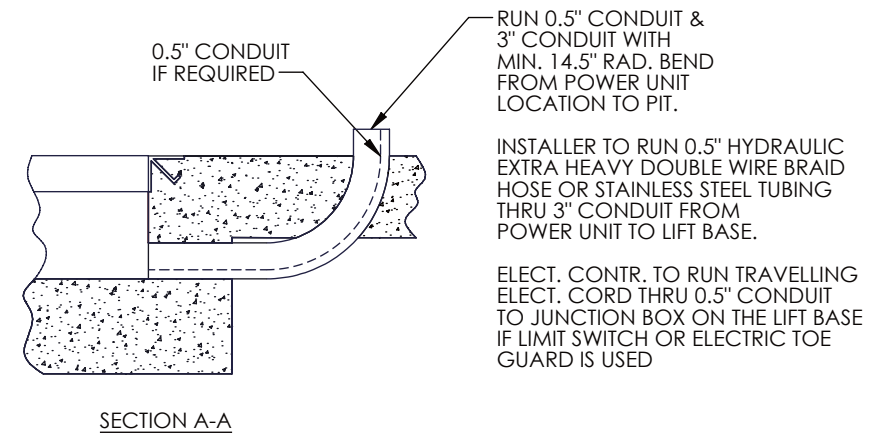
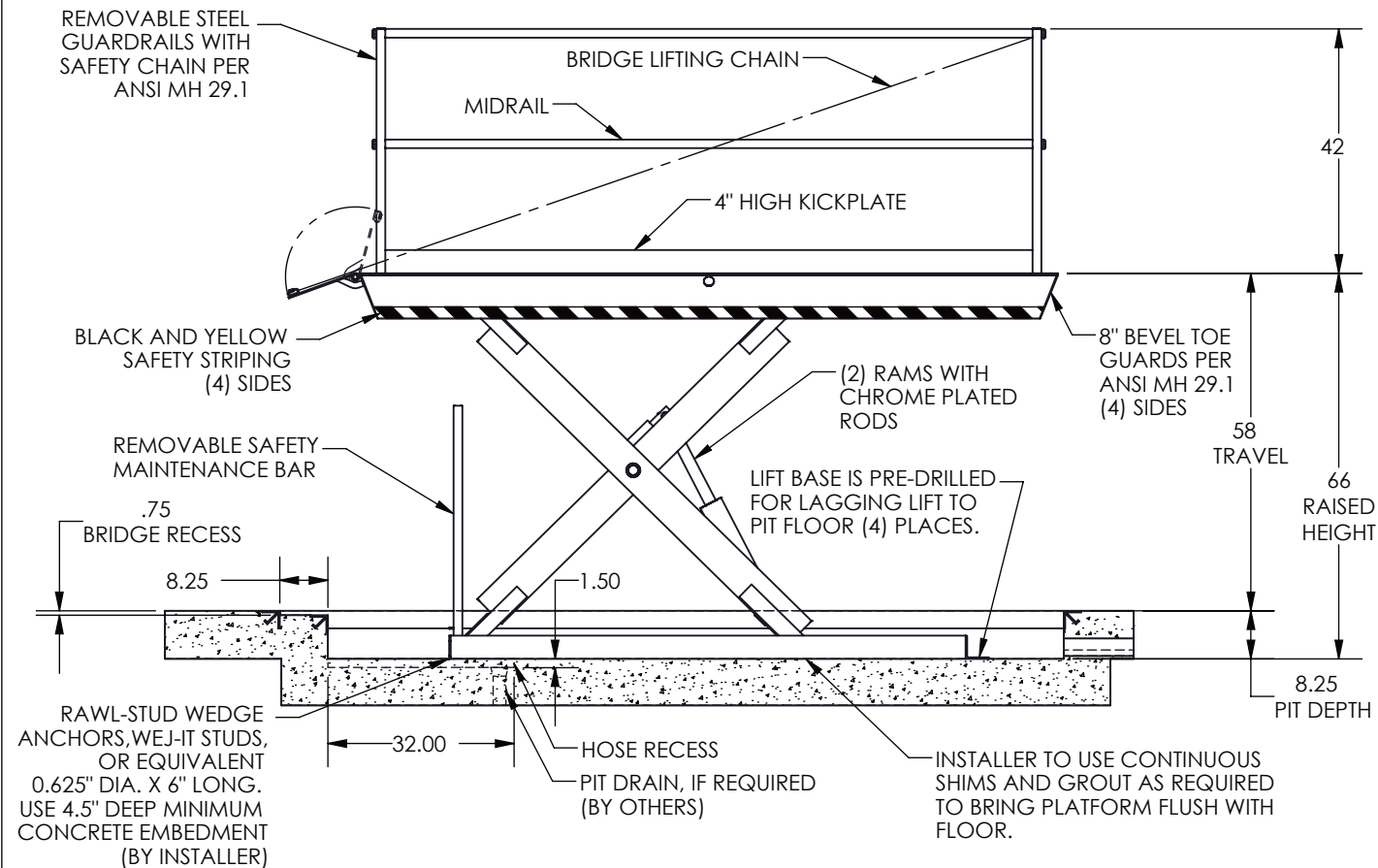

ADVANCE LIFTS Advance Lifts, Inc.
701 S. Kirk Road Phone : 630-584-9881
St. Charles, IL 60174 Fax : 630-584-6837

SCALE	NTS	REVISIONS	BY	DATE
DATE
DR'N
CHKD
JOB NAME				
DESC.	MODEL T3-60610	DWG.	B-	REV.

440v - 480v , 3 Phase Change DETAIL

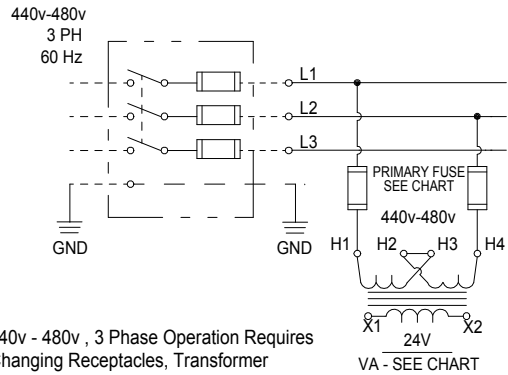

440v - 480v , 3 Phase Operation Requires Changing Receptacles, Transformer Jumper Clips, Motor wiring, changing Motor Overload Protection, and replacing voltage sticker.

208v - 230v , 3 Phase

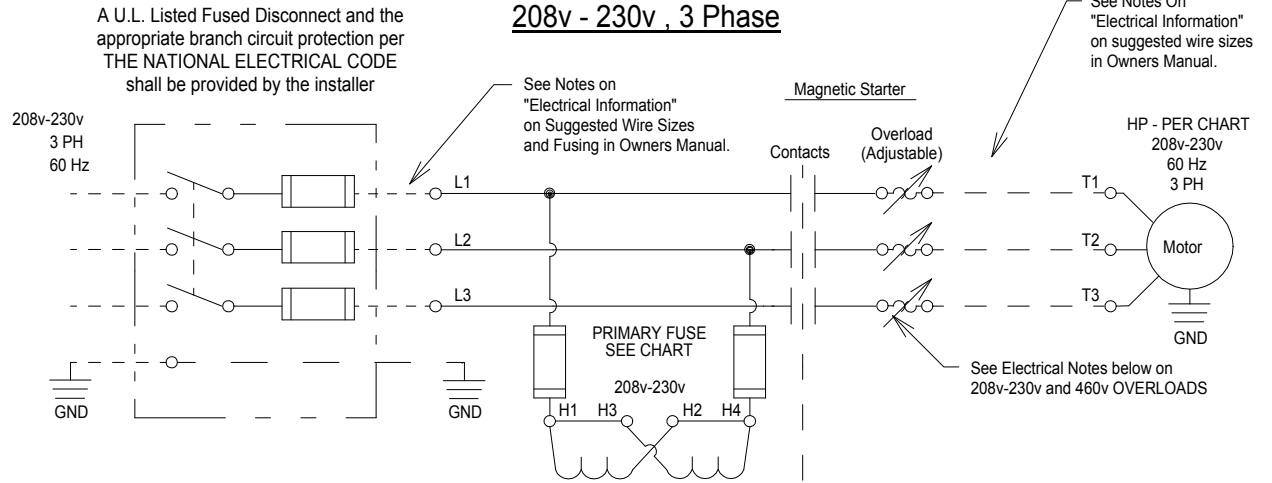

- - DENOTES CONNECTION BLOCK LABELING IN ADVANCE MOTOR CONTROLLER.
- - DENOTES CONTRACTOR WIRING.
- * - UNITS WITH (2) DOWN SOLENOIDS, ALL OTHER UNITS LISTED HAVE (1).

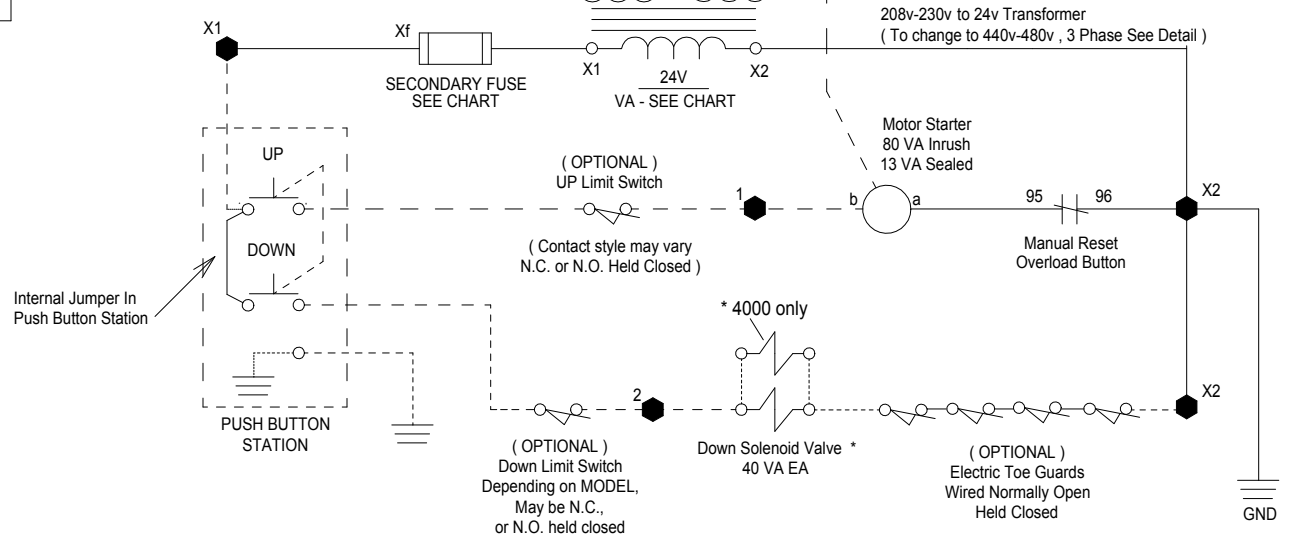



ADVANCE LIFTS

Advance Lifts, Inc.
701 Kirk Road
St. Charles, IL 60174
Phone : 630-584-9881
Fax : 630-584-6837

H.P.	MOTOR R.P.M.	FULL LOAD AMPERAGE (208v-230v / 460v)	TRANSFORMER SIZE	PRIMARY FUSE SIZE (208V-230V/460V)	SECONDARY FUSE SIZE
5	1725	14.8-14 / 7	50 VA	FLM 1/ FLQ 1/2	FNM 3 2/10
7.5	3450	22-20 / 10	100 VA	FLM 1/ FLQ 1/2	FNM 4
-	-	-	-	-	-
-	-	-	-	-	-

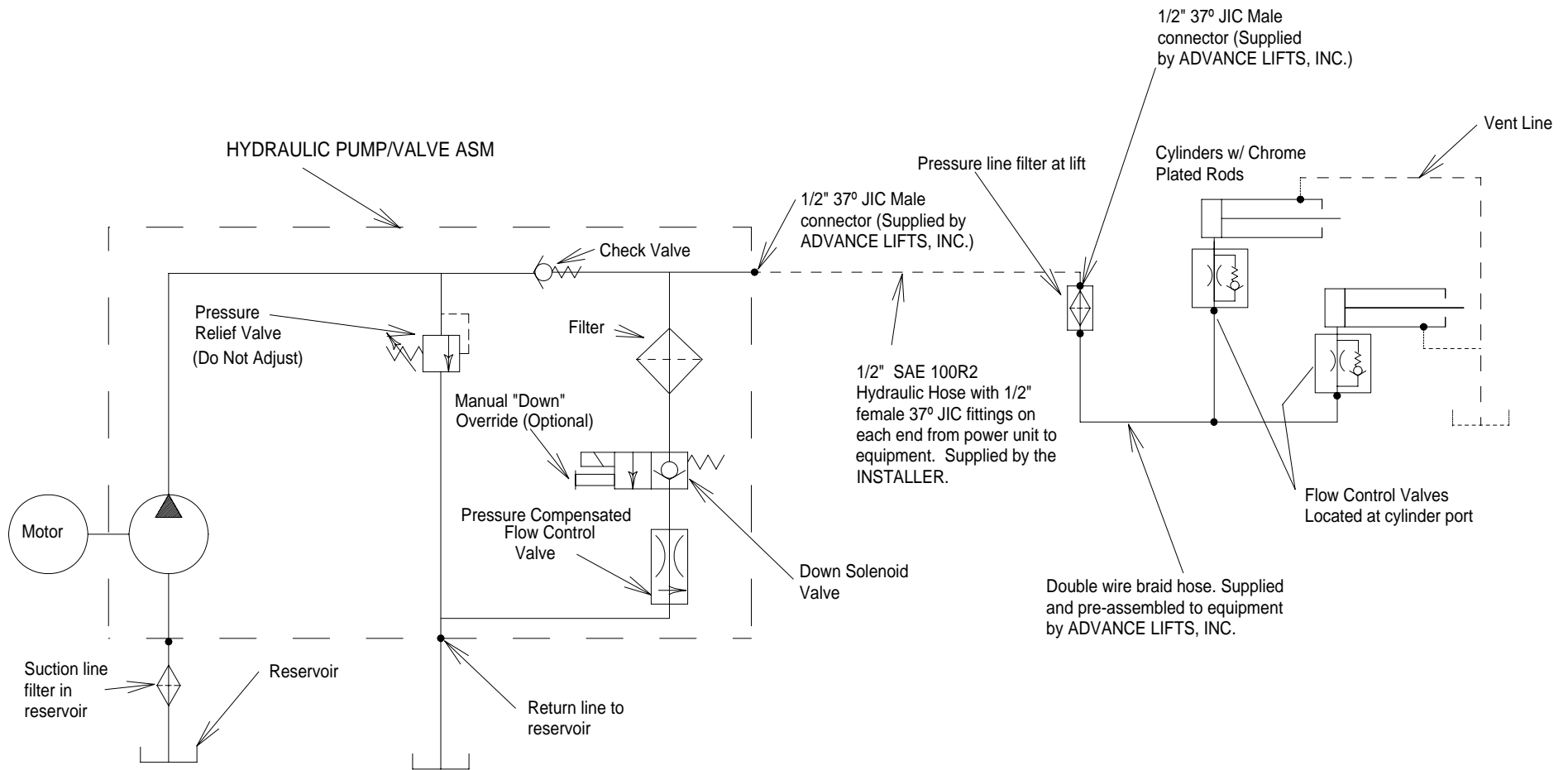
SCALE	N.T.S.	REVISIONS	BY	DATE
DATE	18MAY98	E	MINOR UPDATES INCORPORATED	MM 30JAN01
DRN	CB CKD	F	FUSES ADDED TO TRANSFORMER PRIMARY	EJL 02/13/04
AP'VD		G	PRIMARY FUSES UPDATED IN TABLE	GCJ 1/13/11
DESC.	ELECTRICAL DIAGRAM - U.L. Listed 230v/460v - 3 Phase 24 VAC Control System (Secondary)			EFF. DATE DWG. 22-001
				REV. G



 ADVANCE LIFTS		Advance Lifts, Inc. 701 Kirk Road St. Charles, IL 60174		Phone : 630-584-9881 Fax : 630-584-6837	
		SCALE	NTS	REVISIONS	BY
DATE	08/04/03	C	ADDED VENT LINE	GCJ	8/12/05
DR'N	SR	CKD			
AP'VD					
DESC.	HYDRAULIC DIAGRAM T, TZ, 2, K, 3, 6100, 6150, HD, PUMP W/ BUILT-IN DOWN FLOW VALVE			EFF. DATE	
				DWG.	13-160
				REV.	C