

**GENERAL NOTES**

1. ALL AXLES AND SHAFTS ARE CHROME PLATED.
2. ALL ROLLERS AND PIVOT POINTS ARE EQUIPPED WITH TEFLON SELF-LUBRICATING BEARINGS.
3. 3" VERTICAL AND 4" HORIZONTAL TOE CLEARANCE SIDES.
4. ADVANCE LIFTS, INC. TO SUPPLY:
  - (1) PREWIRED 18' LG. POWER CORD (FROM LIFT BASE TO PLUG).
  - (1) UP/DOWN PUSHBUTTON PENDANT TYPE NEMA 1, 3, 3R, 4, 4X.
5. FINISH: BLUE PAINT.
6. TYPICAL ELECTRICAL DIAGRAM FOR THIS UNIT: E22-1320.  
TYPICAL HYDRAULIC DIAGRAM FOR THIS UNIT: H13-256.

**SPECIFICATIONS:**

CAPACITY : 15,000 LBS MAX. LIFTING CAPACITY  
12,000 LBS MAX. AXLE CAPACITY ENDS

PLATFORM : 72" X 144" SAFETY TREAD DECK  
REMOVABLE GUARDRAILS - STEEL  
18" X 60" STEEL HINGED BRIDGE WITH CHAIN  
42" X 54" CHOCK RAMP- STEEL  
63" BETWEEN CYLINDER UPRIGHT (PLTF WIDTH)  
SAFETY CHAINS

SPEED : 11 FPM

TRAVEL : 54" ( FROM A 6" LOWERED HEIGHT )

LOWERED HEIGHT : 6"

POWER UNIT : 7.5 HP MOTOR, 230V 60Hz 3PH  
SELF CONTAINED AND PRE-WIRED

CONTROLS : UP/DOWN PUSHBUTTON PENDANT  
TYPE NEMA 1, 3, 3R, 4, 4X

IN NEMA 12 ENCLOSURE : MAGNETIC STARTER, W/ OVERLOAD  
230V TO 24 V CONTROL TRANSFORMER.

VOLTAGE: 230V / 3PH  
ADVANCE TO SUPPLY NEMA L15-30P PLUG  
CUSTOMER TO SUPPLY: NEMA L15-30R RECEPTACLE

APPROXIMATE SHIPPING WEIGHT: 5,790 LBS.

ALL DIMENSIONS ARE GIVEN IN INCHES UNLESS OTHERWISE NOTED.

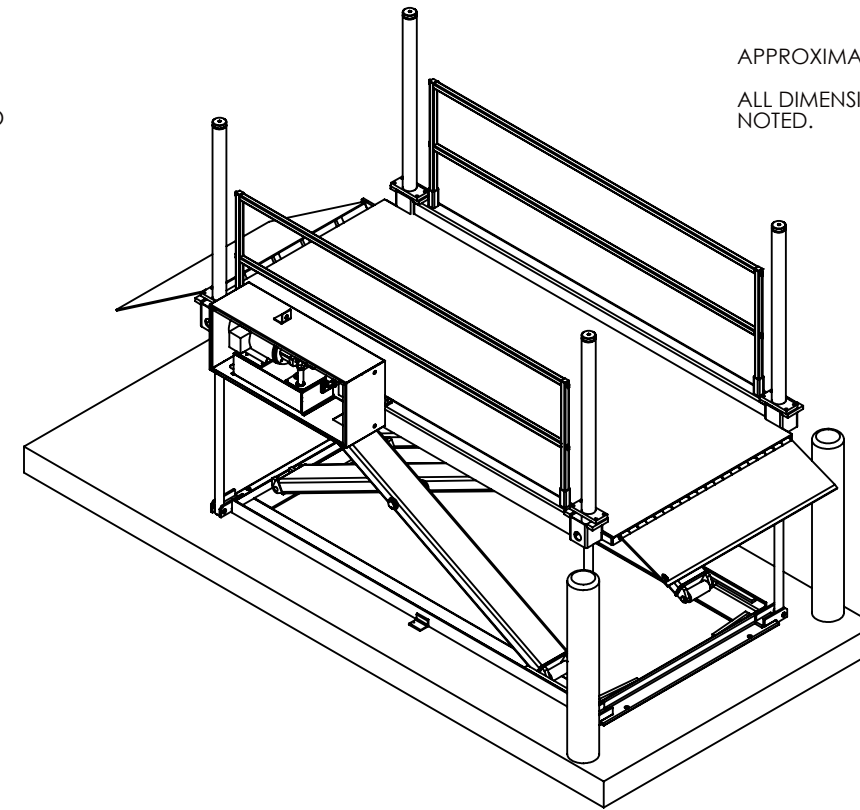

 <b>ADVANCE LIFTS</b>		Advance Lifts, Inc. 701 S. Kirk Road St. Charles, IL 60174		Phone : 630-584-9881 Fax : 630-584-6837	
SCALE	NTS	REVISIONS	BY	DATE	
DATE	.	.	.	.	.
DR'N	.	.	.	.	.
CHKD	.	.	.	.	.
JOB NAME					
DESC.	MODEL 615612			DWG.	B-
				REV.	